

MANITOWOC

4000 W

LIFT • RINGER® • TOWER •

CLAM • DRAG

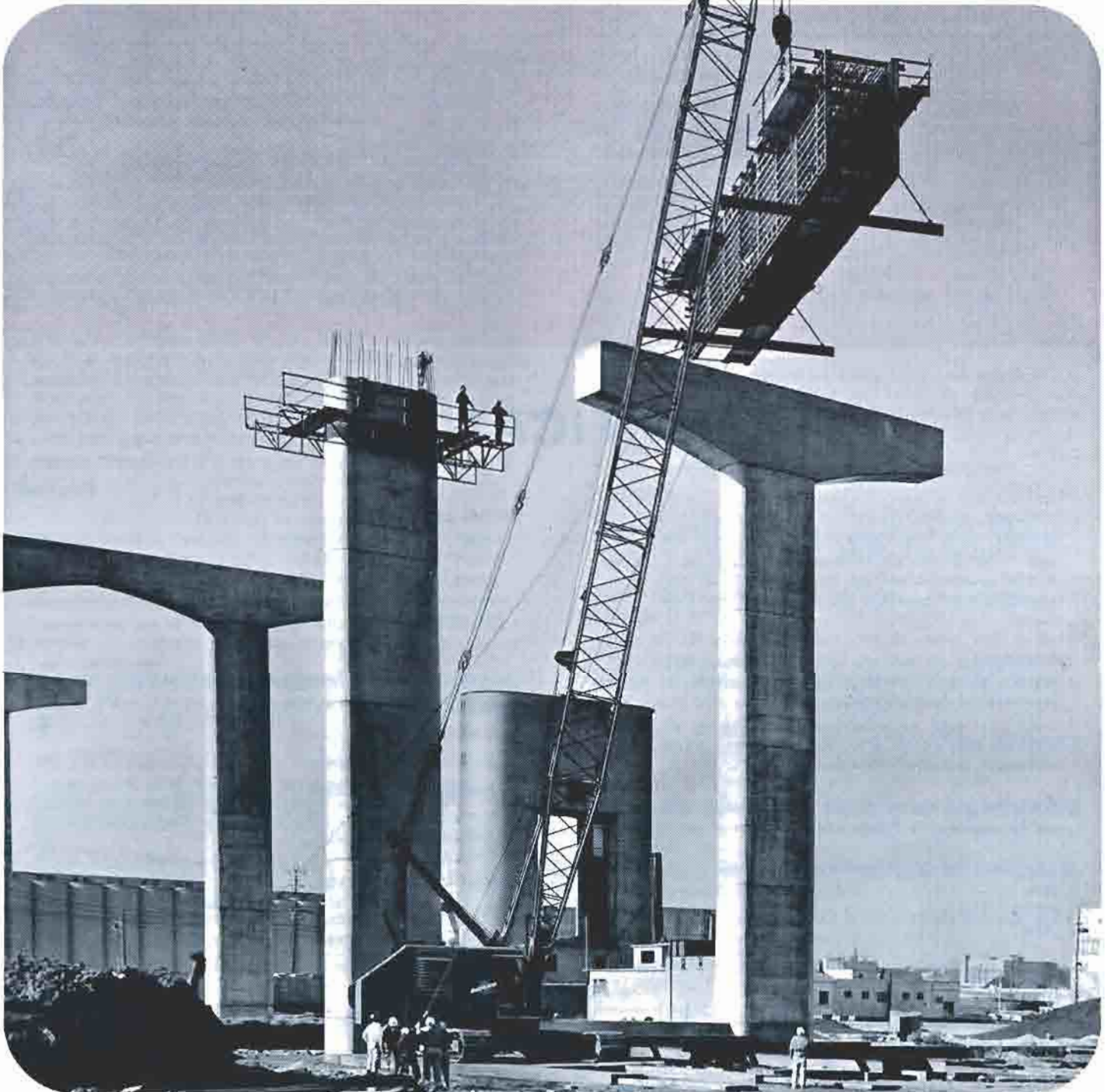

OUTLINE DIMENSIONS

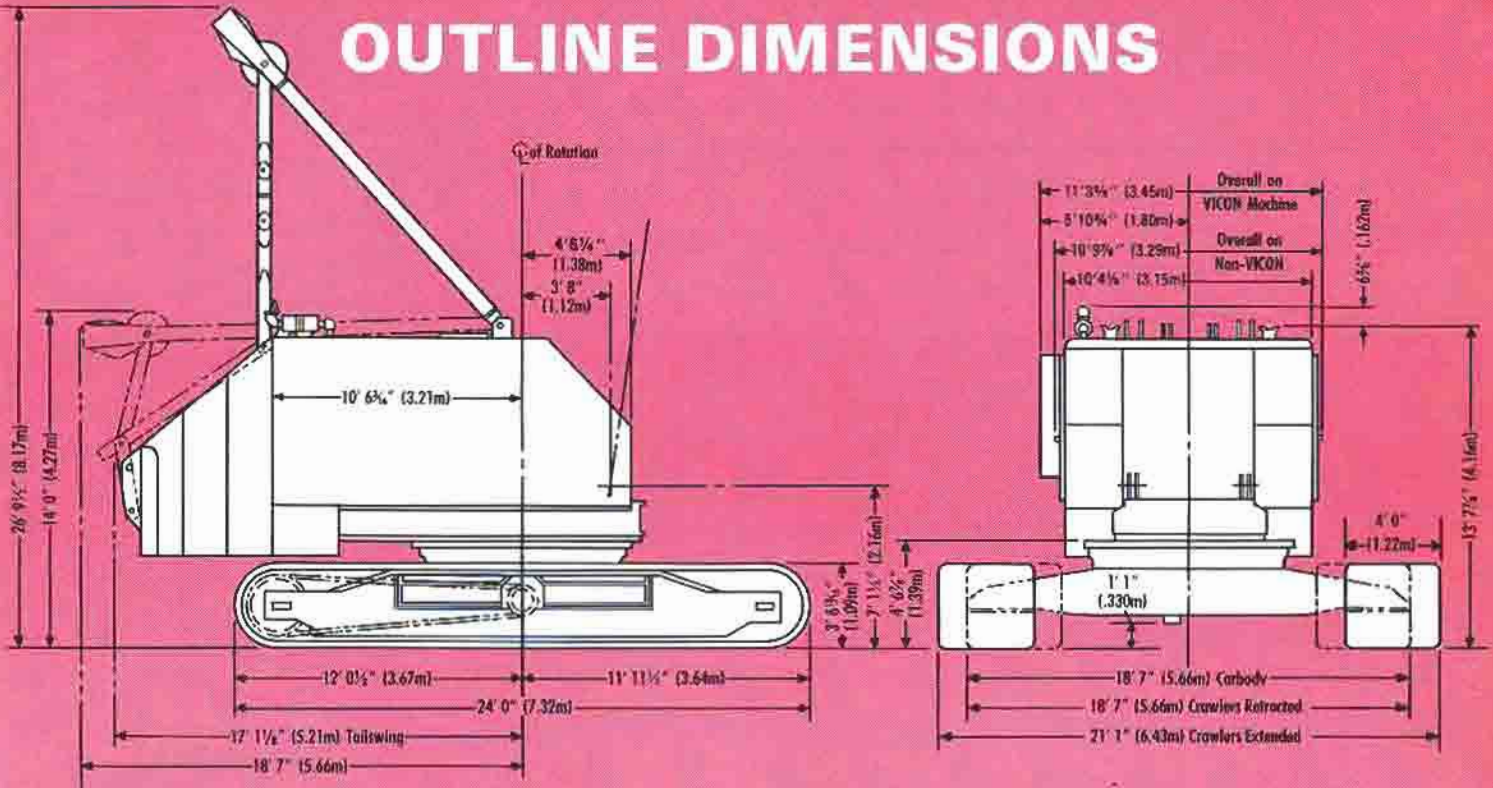

SPECIFICATIONS

WEIGHTS

Pounds*

LIFTCRANE , complete with 70' No. 22 Boom, gantry and backhitch, boom hoist rigging and pendants, hoist wire rope, 15-ton swivel-type hook and weight ball, basic VICON® upperworks package, counterweights, 24' long extendible width crawlers, and outside crawler drive chains	315,160
UPPERWORKS , complete with basic VICON® machinery, including drums and gantry, but not including front end assemblies or counterweights	77,865
CARBODY with center pin, roller path, and travel mechanism, but without crawlers	41,010
CRAWLERS with crawler frames, crawler treads, and outside crawler chain (each crawler 35,520)	71,040
SELF-REMOVING COUNTERWEIGHT (3 piece)	
Inner	40,100
Middle	35,800
Outer	28,500
BOOM NO. 22	
Boom Butt (less wire rope and pendants)	6,150
Boom Top (equipped with lower and upper boom point assemblies and basic pendants)	10,530

Pounds*

BOOM INSERTS

Insert — 10' (with pendants)	1,810
Insert — 20' (with pendants)	3,055
Insert — 30' (with pendants)	5,320

*Weights are approximate and may vary between machines as a result of design changes and component variations.

EXTENDIBLE CRAWLERS

CRAWLER WIDTH — Extendible from 18'7" to 21'1"	
CRAWLER LENGTH — Over ends	24'0"
TREAD WIDTH	48"
Number of pads per crawler	52
INTERMEDIATE ROLLERS	
Number per crawler	12
Roller diameter	14"
Roller shaft diameter	4 3/8"
FRONT IDLER DIAMETER	34"
Roller shaft diameter	6 1/4"
DRIVE SPROCKET DIAMETER	35"

ADJUSTMENT: Adjustment of the crawler belt tension is accomplished by a jack and shim system.

CUSHIONED: A shock absorber is mounted in the crawler belt tension adjustment system.

POWER PLANT

Model		Cyl.	Bore	Stroke	Cu. In. Displacement	Net HP @ RPM (at flywheel)
BASIC	Cummins NS-743-B320 Diesel ¹	6	5.125"	6.0"	743	290 @ 2000
OPTIONAL	Cummins NTA-855-B380 Diesel ²	6	5.500"	6.0"	855	333 @ 2000
	GM 8V-71N Diesel ³	8	4.250"	5.0"	568	278 @ 2000
	GM 12V-71N Diesel ³	12	4.250"	5.0"	852	363 @ 1800
	Caterpillar D343-T Diesel ²	6	5.400"	6.5"	893	298 @ 2000
	Caterpillar D343-TA Diesel ²	6	5.400"	6.5"	893	364 @ 2000
Air Compressor: 37.5 CFM					Fuel Tank Capacity: 210 gal.	
¹ Available with or without VICON® control system.		² Available only with VICON.		³ Not available with VICON.		

POWER TRANSMISSION CONTROL

An engine mounted three-stage torque converter drives all machinery components. Speed and power output requirements are governed by engine RPM, which is controlled by the hand and/or foot throttle. Optional converter-to-machinery sprocket ratios are available. Consult factory.

VICON CONTROL SYSTEM (OPTIONAL)

The exclusive VICON control system enables stepless variable speed output from two controlled torque converters, driven by a primary power plant. One converter drives the load hoist and boom hoist machinery, the other the swing and travel machinery. Torque and speed are variably controlled from two independent power sources, without slipping clutches or brakes (U.S. Patent No. 3,221,986).

SWING AND TRAVEL CLUTCHES

CLUTCH SHAFT: Double-disc clutch (single-disc clutch on machines with VICON CONTROL SYSTEM option), with 2-piece replaceable friction discs. Cams, pinions, and clutch components are antifriction bearing mounted. Pinions are lubricated by a circulating oil system.

SWING SPEED: Main Drive Shaft — Variable, 0 to 4.5 RPM.
Independent Swing Shaft —
Standard: Variable, 0 to 1.5 RPM
Optional: Variable, 0 to 4.4 RPM

TRAVEL SPEED: Variable, 1.4 MPH maximum.

GRADEABILITY: 30%.

INDEPENDENT SWING

Independent set of swing clutches with separate power train permits simultaneous operation of swing, travel, and boom hoist machinery.

CLUTCH SHAFT: Double-disc clutch with 2-piece replaceable friction discs. Cams, pinions, and clutch components are antifriction bearing mounted.

ROTATING BED

Single piece steel weldment with integral machinery side frames, jig bored to assure precision alignment.

HOUSE ROLLERS — 6: 4 Front, bushing mounted.
2 Rear, antifriction bearing mounted.

HOOK ROLLERS — 6: 2 Front, bushing mounted.
4 Rear, bushing mounted.

RING GEAR — ROLLER PATH: 105% diameter with 4¾" face, machined internal-type teeth, bolted to carbody.

POWER LOAD LOWERING (OPTIONAL)

VICON POWER LOWERING

Power lowering is an integral part of the VICON CONTROL SYSTEM option on the 4000W. This system enables raising,

holding, or controlled lowering of the load by means of hoist converter variable torque output. Hoist clutch remains in constant engagement, making transfer of the load from clutch to brake unnecessary during normal job cycle.

FULL-RANGE VICON POWER LOWERING

The load hoist drive train is driven in the down direction by a hydraulic motor through an oil-spray lubricated direct chain drive. Hydraulic pump is driven by the main output shaft of the primary power plant. Antifriction bearings are standard. The hoist clutch remains engaged during lowering, with speed and braking controlled by the converter valve. The power load lowering control is located on the load hoist control lever.

CLUTCH-AND-RETARDER POWER LOWERING

This device is designed for heavy duty load lowering with Model 4000W cranes not equipped with the VICON control system.

A load lowering clutch on the main drive shaft interconnects a chain drive to the hoist drum. Hydraulic retarder, with heat exchanger, in the primary drive absorbs load energy. Clutch can be disengaged to lower a load rapidly, without stopping machinery drive train. The power load lowering control is located near the load hoist control lever.

INDEPENDENT BOOM HOIST

CLUTCH SHAFT: Two-piece double-disc clutch. Roller bearing clutch cams, antifriction bearing mounted bevel pinions and clutch components.

WORM GEAR AND WHEEL: Bronze, fully enclosed, lubricated by circulating oil; antifriction bearings.

DUAL BOOM HOIST DRUMS: Provide equal pull to boom hoist rigging.

BRAKE: Automatic, band-type, spring-applied, air-released in conjunction with clutch engagement.

AUXILIARY BRAKE: Independent, band type, manually applied brake.

BOOM STOPS

AUTOMATIC BOOM STOP: The automatic boom stop is set to stop boom hoisting when boom angle reaches 82° above horizontal.

PANTOGRAPH BOOM STOP: The pantograph boom stop provides a mechanical stop at 85°.

TELESCOPIC BOOM STOP: Air Cushioned. (In place of pantograph boom stop.)

Optional with No. 17 Boom: Starts cushioning at 78°, with final physical stop at 88½°.

Standard with No. 22 Boom: Starts cushioning at 77°, with final physical stop at 86°.

DRUM AND LAGGING CHART

SPLIT DRUM SHAFT		Drum	Drum or Lagging Dia.	Drum Width	Type of Lagging	Wire Rope Size	Spooling Capacity		
Application							First Layer	Layers	Max. Capacity
LIFTCRANE	Hoist	Right	19"	20 $\frac{3}{8}$ " ¹	None	1 $\frac{1}{8}$ "	88' (72') ¹	7	823' (679') ¹
	Whip	Left	21"	14 $\frac{3}{8}$ "	Plain	1 $\frac{1}{8}$ "	68'	6	514'
	Auxiliary	Rear Aux.	17"	34 $\frac{1}{2}$ " ²	None	$\frac{7}{8}$ "	168' (156') ²	3	554' (516') ²
CLAMSHELL With VICON	Closing Holding	Right	27"	20 $\frac{3}{8}$ "	Grooved	1 $\frac{1}{8}$ "	123'	3	398'
		Left	27"	14 $\frac{3}{8}$ "	Grooved	1 $\frac{1}{8}$ "	87'	3	281'
CLAMSHELL Without VICON	Closing Holding	Right	28"	20 $\frac{3}{8}$ " ¹	Grooved	1"	131' (108') ¹	4	584' (481') ¹
		Left	27"	14 $\frac{3}{8}$ "	Grooved	1"	98'	3	309'
DRAGLINE With Revolving Fairlead	Drag Hoist	Right	24"	20 $\frac{3}{8}$ " ¹	Grooved	1 $\frac{1}{4}$ "	97' (80') ¹	2	205' (169') ¹
		Left	27"	14 $\frac{3}{8}$ "	Grooved	1"	98'	3	309'

SINGLE DRUM SHAFT		Drum	Drum or Lagging Dia.	Drum Width	Type of Lagging	Wire Rope Size	Spooling Capacity		
Application							First Layer	Layers	Max. Capacity
LIFTCRANE	Hoist	Front	19"	37 $\frac{1}{4}$ "	None	1 $\frac{1}{8}$ "	161'	7	1505'
	Whip	Rear Aux.	17"	34 $\frac{1}{2}$ " ²	None	$\frac{7}{8}$ "	168' (156') ²	3	554' (516') ²

1. Drum Width — 16.8" when equipped with clutch-and-retarder power lowering.
 2. Drum Width — 32 $\frac{1}{2}$ " when equipped with ratchet ring.

Drwg. No. 4865, 8-8-68

LIFTCRANE BOOM NO. 22

The No. 22 Boom is optional for the Model 4000W. Constructed of inverted angle chord members with tubular lacing; box section 95" wide x 95" deep at the pin connected joints. 30' butt section; 40' open-throat top section with six antifriction bearing sheaves.

Insert sections in 10', 20', and 40' lengths are available. Inserts are provided with matched pendant rigging. Wire rope roller guides are mounted on inserts.

WIRE ROPE GUIDE: Two antifriction bearing sheaves, floating.

PENDANT TYPE RIGGING: Set of four 1 $\frac{1}{8}$ " diameter wire rope pendants. Pendants matched to insert length.

EQUALIZER: Equalizer assembly for 12-part boom hoist rigging with antifriction bearing sheaves.

GANTRY: Universal gantry with telescopic link-type back hitch straps. Antifriction bearings in vertical gantry sheaves.

GANTRY LIFTING DEVICE: The gantry lifting device is an electrically powered hydraulic unit that assists in raising the gantry, and in lowering of gantry to cab roof.

OPTIONAL

UPPER BOOM POINT: Detachable, with either one or two 36" dia. wide-flange antifriction bearing sheaves, with or without cheek plate.

4 $\frac{1}{2}$ " OFFSET BOOM TOP: For capacity charts and information, contact factory.

JIB ADAPTER: Required for jib attachment; cannot be used with upper boom point.

NO. 123 JIB: 20-ton nominal capacity, 30' length, extendible to 60' with 10' inserts. Tubular chord members and lacing; 30" x 30" box section at the pin connected joints. Furnished with single-part hoist line, and anchor joint for two-part line. Strut: 12' 6" standard (9' 0" optional with reduced capacities).

Nominal Capacities with Inserts:

40' — 15 tons 50' — 10 tons 60' — 5 tons

NO. 124 JIB: 10-ton nominal capacity, 30' length extendible to 60' with 10' inserts. Tubular chord members and lacing; 29 $\frac{1}{2}$ " wide x 22" deep section at the pin connected joints. Furnished with single-part hoist line.

Strut: 18' standard (7' 0" and 12' 6" optional with reduced capacities).

Nominal Capacities with Inserts:

40' — 7 tons 50' — 5 tons 60' — 2.5 tons

Because of a program of continuing improvements, Manitowoc Engineering Co. reserves the right to change specification data at any time, without notice.

MANITOWOC ENGINEERING CO.

(A division of The Manitowoc Company, Inc.)

Manitowoc, Wisconsin 54220

